

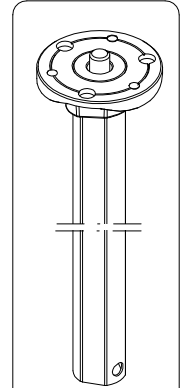

ART. 190CXV3

For serial number
from Axxxx

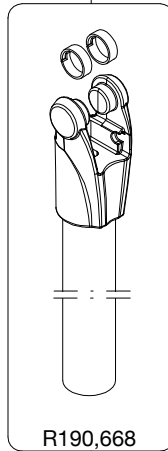
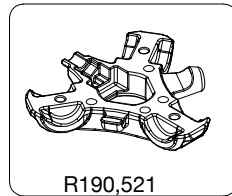
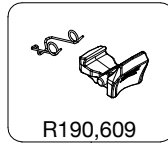
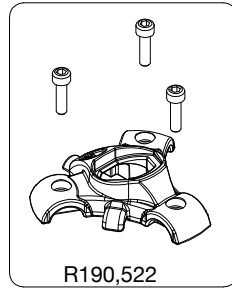
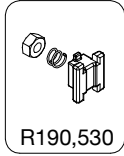
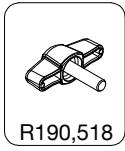

R190,716

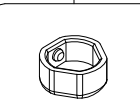

R190,320

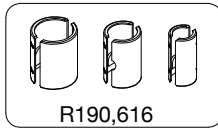

R190,616

TO BE MOUNTED
ON TUBES

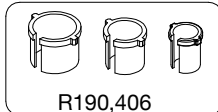

R190,406

TO BE MOUNTED
ON CLAMPING-COLLARS

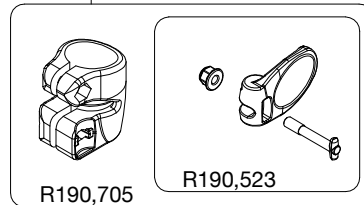

R190,523

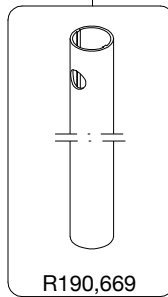

Tool (TORX T25) included in :
- Spare part R190,705
- Spare part R190,706

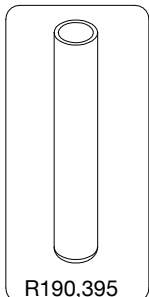

R190,395

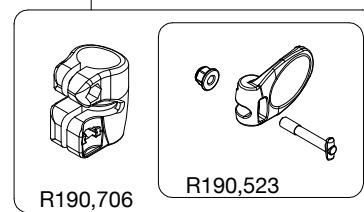
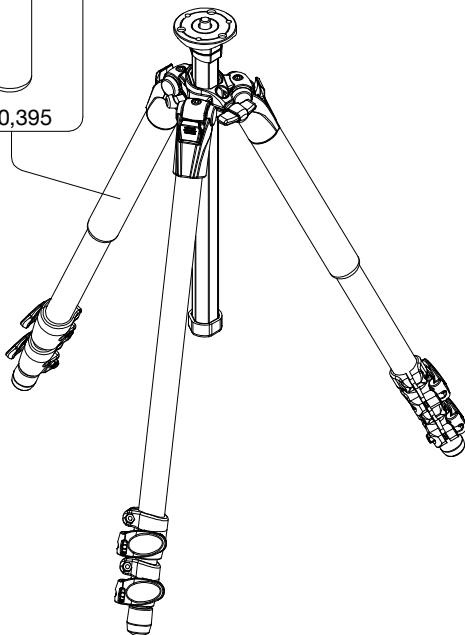

R190,523

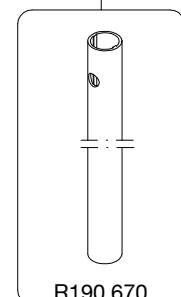

R190,670

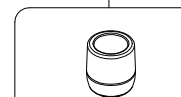

R190,526 Set of 3